

Side Hung Turn Only Systems Поворотная система

- 04.01.00** System Groups
Система групп
- 04.02.00** Turn Only Espagnolette 15 mm Backset
Поворотный Механизм 15 мм
- 04.03.00** Turn Only Espagnolette 7,5 mm Backset
Поворотный Механизм 7,5 мм
- 04.04.00** Turn Only Espagnolette 22 mm Backset
Поворотный Механизм 22 мм
- 04.05.00** Turn Only Espagnolette 25 mm Backset
Поворотный Механизм 25 мм
- 04.06.00** Turn Only Espagnolette 40 mm Backset
Поворотный Механизм 40 мм
- 04.07.00** Sliding Espagnolette 15 mm Backset (With Additional Lock)
Раздвижной Механизм с Замком 15 мм. (корпус замка)
- 04.08.00** Fixed Handle Height Reversing Espagnolettes
Поворотно-противоположные проивод



Side Hung Turn Only Systems Поворотная система



System Groups / Side Hung Turn Only Systems / Symmetrical Hinge Group Система групп / Поворотная система / Среднеприжимной комплект

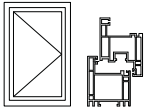

1	V.01/110.15.01	VGR1		SK0 (480-730 mm)
	V.01/120.15.01	VGR2		SK1 (730-1180 mm)
	V.01/160.15.01	VGRS	T&T Espagnolette V.H.H. (15 mm. Backset)	SK1 (950-1400 mm)
	V.01/130.15.01	VGR3	Поворотно-Откидной Запор	SK1 (1180-1630 mm)
	V.01/140.15.01	VGR4		SK2 (1630-2080 mm)
V.01/150.15.01	VGR5		SK2 (1900-2350 mm)	
3	V.03/300.00.01	VOK0		SK1 (400-850 mm)
	V.03/310.00.01	VOK1		SK2 (850-1300 mm)
	V.03/360.00.01	VOK1S		SK2 (850-1400 mm)
	V.03/320.00.01	VOK2	Middle Lock	SK2 (1200-1500 mm)
	V.03/330.00.01	VOK3	Промежуточное Запирание	SK3 (1400-1700 mm)
	V.03/340.00.01	VOK4		SK3 (1600-2050 mm)
V.03/350.00.01	VOK5		SK4 (2000-2350 mm)	
4	V.04/400.00.01	VCD1	Corner Drive Угловой Переключатель	155 SK1 x 130
6	V.06/800.00.01	VYK	Horizontal Extension Lock Горизонтальное Запирание	SK1 (490 mm)
11	V.07/910.XX.01	VUM..	Top Sash Hinge (9/13) Верхняя Петля Створки	Strikers List
12	V.07/920.00.01	VUMF	Top Frame Hinge Верхняя Петля Рамы	
13	V.07/930.00.01	VKM1	Bottom Frame Hinge Нижняя Петля Рамы	Strikers List
13a	V.07/930.01.01	VKM3	Bottom Frame Hinge (130 kg) Нижняя Петля Рамы	
14	V.07/940.00.01	VKM2	Bottom Sash Hinge (130 kg) Нижняя Петля Створки	
15	V.15/905.05.XX	VKP.XX	Cover Caps-Standard Комплект Петлевых Декоров	Strikers List
15a	V.15/905.01.XX	VKPM.XX	Cover Caps-Middle Hinge Комплект Петлевых Декоров для Баз. Комп.	
18	V.07/900.00.01	VAM	Adjustable Sash Hinge Регулируемая Верхняя Петля Створки	
22	V.05/575.00.01	VOBML	Middle Hinge Rod Лама Среднего Прижима	
22a	V.05/580.XX.01	VABM..	Adjustable Middle Hinge (9/13) Регулируемая средняя петля	
26	V.21/050.15.01	VTA-0		280 mm SK2 (280 mm)
	V.21/100.15.01	VTA-1		400 mm SK2 (300-600 mm)
	V.21/110.15.01	VTA-2		600 mm SK2 (500-800 mm)
	V.21/120.15.01	VTA-3		800 mm SK2 (700-1000 mm)
	V.21/130.15.01	VTA-4	Turn Only Espagnolette	1000 mm SK3 (900-1200 mm)
	V.21/140.15.01	VTA-5	Поворотный Запор	1200 mm SK3 (1100-1400 mm)
	V.21/150.15.01	VTA-6		1400 mm SK3 (1300-1600 mm)
	V.21/160.15.01	VTA-7		1600 mm SK3 (1500-1800 mm)
	V.21/170.15.01	VTA-8		1800 mm SK4 (1700-2000 mm)
	V.21/180.15.01	VTA-9		2000 mm SK4 (1900-2200 mm)
V.21/190.15.01	VTA-10		2200 mm SK4 (2100-2400 mm)	
29a	V.04/408.01.01	VAK2	Turn Only (Top/Bottom) Lock 155 mm Поворотный Замок (Верхний/Нижний)	
32	V.07/580.00.01	VGM	Center Lock Среднеприжимная Петля	Strikers List
33	V.07/580.XX.01	VGMK..	Center Lock Striker (9/13) Ответная Планка Среднеприжимной Петли	
35	V.07/1XX.XX.01	VKK.XX	Gear Keeps (9/13) Ответная Планка	Strikers List

Side Hung Turn Only Systems

Поворотная система



System Groups / Side Hung Tilt Only Systems / Symmetrical Hinge Group
 Система групп / Фрамужная система / Среднеприжимной комплект

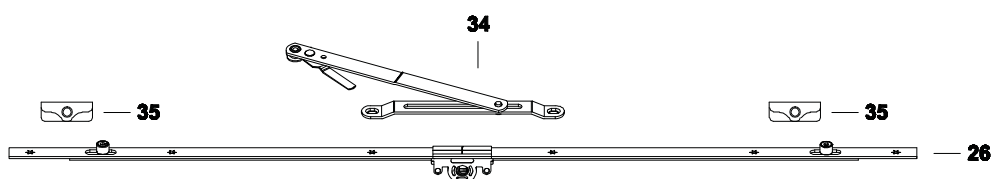
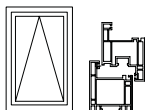

11	V.07/910.XX.01	VUM..	Top Sash Hinge (9/13) Верхняя Петля Створки	Strikers List
12	V.07/920.00.01	VUMF	Top Frame Hinge Верхняя Петля Рамы	
15a	V.15/905.01.XX	VKPM.XX	Cover Caps-Middle Hinge Комплект Петлевых Декоров для Баз. Комп.	
22	V.05/575.00.01	VOBML	Middle Hinge Rod Лама Среднего Прижима	
26	V.21/050.15.01	VTA-0		280 mm SK2 (280 mm)
	V.21/100.15.01	VTA-1		400 mm SK2 (300-600 mm)
	V.21/110.15.01	VTA-2		600 mm SK2 (500-800 mm)
	V.21/120.15.01	VTA-3		800 mm SK2 (700-1000 mm)
	V.21/130.15.01	VTA-4	Turn Only Espagnolette	1000 mm SK3 (900-1200 mm)
	V.21/140.15.01	VTA-5	Поворотный Запор	1200 mm SK3 (1100-1400 mm)
	V.21/150.15.01	VTA-6		1400 mm SK3 (1300-1600 mm)
	V.21/160.15.01	VTA-7		1600 mm SK3 (1500-1800 mm)
	V.21/170.15.01	VTA-8		1800 mm SK4 (1700-2000 mm)
	V.21/180.15.01	VTA-9		2000 mm SK4 (1900-2200 mm)
V.21/190.15.01	VTA-10		2200 mm SK4 (2100-2400 mm)	
34	V.07/200.00.01	VVM	Tilt Stay (Adaptable To Espagnolette) Фрамужная Ножница (Регулируемая)	
35	V.07/1XX.XX.01	VKK.XX	Gear Keeps (9/13) Ответная Планка	Strikers List

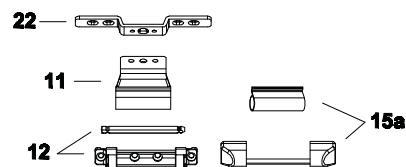
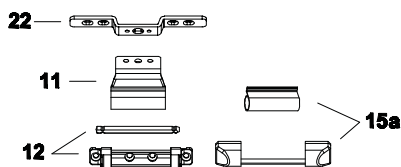

Side Hung Turn Only Systems





Поворотная система

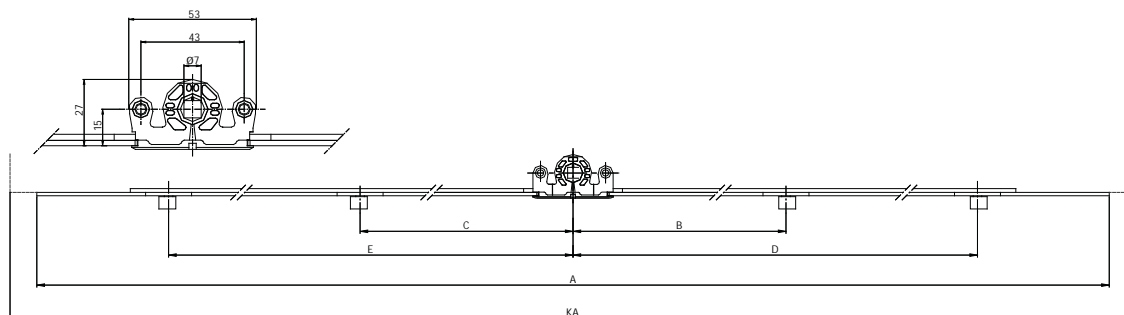

Turn Only Espagnolette 15 mm Backset (Zamak Gearbox - Standard Locking Pin)

Поворотный Механизм 15 мм. (корпус замка)





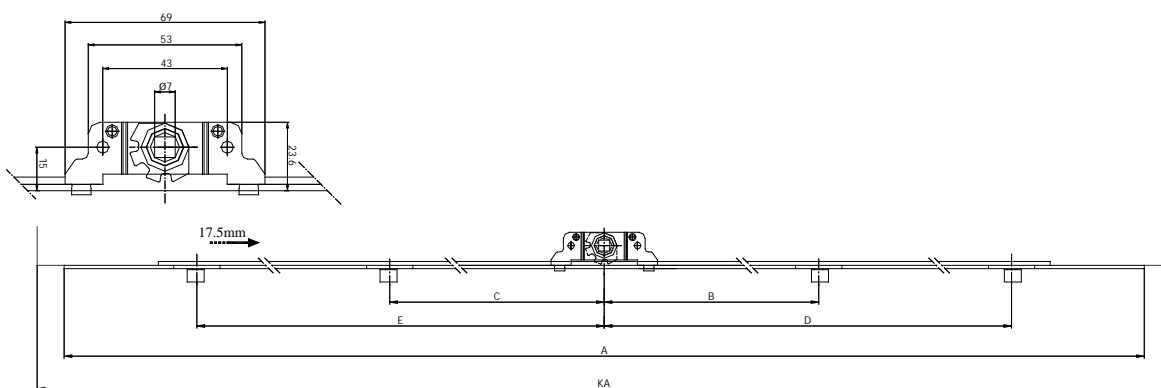

 (Short Code)		KA	Usage Length	A	B	C	D	E	  		
V.21.050.15.01	VTA-0	280	280	96	114	-	-	4	2	60	
V.21.100.15.01	VTA-1	300-600	400	96	114	-	-	6	2	20	
V.21.110.15.01	VTA-2	500-800	600	165,5	183,5	-	-	6	2	20	
V.21.120.15.01	VTA-3	700-1000	800	265,5	283,5	-	-	8	2	20	
V.21.130.15.01	VTA-4	900-1200	1000	365,5	144	-	383,5	10	3	20	
V.21.140.15.01	VTA-5	1100-1400	1200	465,5	144	-	483,5	10	3	20	
V.21.150.15.01	VTA-6	1300-1600	1400	565,5	144	-	583,5	12	3	20	
V.21.160.15.01	VTA-7	1500-1800	1600	665,5	144	-	683,5	13	3	20	
V.21.170.15.01	VTA-8	1700-2000	1800	249,5	267,5	765,5	783,5	14	4	20	
V.21.180.15.01	VTA-9	1900-2200	2000	282,5	300,5	865,5	883,5	16	4	20	
V.21.190.15.01	VTA-10	2100-2400	2200	282,5	300,5	965,5	983,5	16	4	20	

Turn Only Espagnolette 15 mm Backset (Steel Gearbox - Standard Locking Pin)

Поворотный Механизм 15 мм. (корпус сталь)



 (Short Code)		KA	Usage Length	A	B	C	D	E	  		
V.22.050.15.01	VTAS-0	280	280	96	114	-	-	4	2	60	
V.22.100.15.01	VTAS-1	300-600	400	96	114	-	-	6	2	20	
V.22.110.15.01	VTAS-2	500-800	600	165,5	183,5	-	-	6	2	20	
V.22.120.15.01	VTAS-3	700-1000	800	265,5	283,5	-	-	8	2	20	
V.22.130.15.01	VTAS-4	900-1200	1000	365,5	144	-	383,5	10	3	20	
V.22.140.15.01	VTAS-5	1100-1400	1200	465,5	144	-	483,5	10	3	20	
V.22.150.15.01	VTAS-6	1300-1600	1400	565,5	144	-	583,5	12	3	20	
V.22.160.15.01	VTAS-7	1500-1800	1600	665,5	144	-	683,5	13	3	20	
V.22.170.15.01	VTAS-8	1700-2000	1800	249,5	267,5	765,5	783,5	14	4	20	
V.22.180.15.01	VTAS-9	1900-2200	2000	282,5	300,5	865,5	883,5	16	4	20	
V.22.190.15.01	VTAS-10	2100-2400	2200	282,5	300,5	965,5	983,5	16	4	20	

Side Hung Turn Only Systems





Поворотная система

VHS

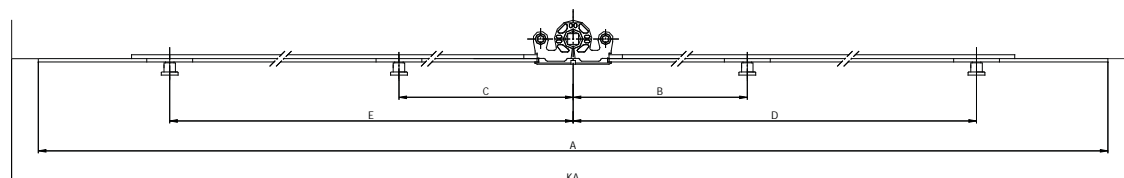
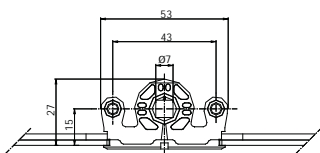
Sliding Espagnolette 15 mm Backset (Zamak Gearbox - Security Locking Pin)

Раздвижной Механизм 15 мм. (корпус замка)





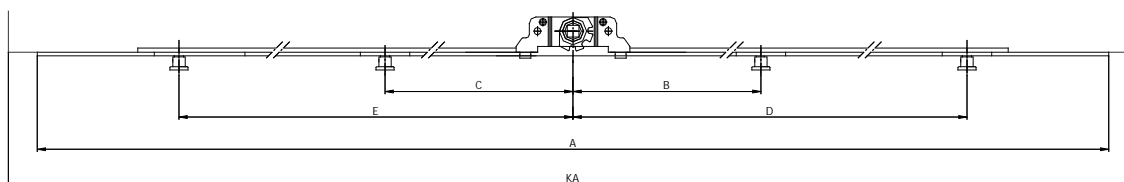
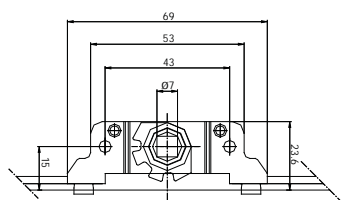

 (Short Code)		KA Usage Length	A	B	C	D	E	  		
V.23.050.15.01	VSTA-0	280	280	96	114	-	-	4	2	60
V.23.100.15.01	VSTA-1	300-600	400	96	114	-	-	6	2	20
V.23.110.15.01	VSTA-2	500-800	600	165,5	183,5	-	-	6	2	20
V.23.120.15.01	VSTA-3	700-1000	800	265,5	283,5	-	-	8	2	20
V.23.130.15.01	VSTA-4	900-1200	1000	365,5	144	-	383,5	10	3	20
V.23.140.15.01	VSTA-5	1100-1400	1200	465,5	144	-	483,5	10	3	20
V.23.150.15.01	VSTA-6	1300-1600	1400	565,5	144	-	583,5	12	3	20
V.23.160.15.01	VSTA-7	1500-1800	1600	665,5	144	-	683,5	13	3	20
V.23.170.15.01	VSTA-8	1700-2000	1800	249,5	267,5	765,5	783,5	14	4	20
V.23.180.15.01	VSTA-9	1900-2200	2000	282,5	300,5	865,5	883,5	16	4	20
V.23.190.15.01	VSTA-10	2100-2400	2200	282,5	300,5	965,5	983,5	16	4	20

Sliding Espagnolette 15 mm Backset (Steel Gearbox - Security Locking Pin)

Раздвижной Механизм 15 мм. (корпус сталь)



 (Short Code)		KA Usage Length	A	B	C	D	E	  		
V.24.050.15.01	VSTAS-0	280	280	96	114	-	-	4	2	60
V.24.100.15.01	VSTAS-1	300-600	400	96	114	-	-	6	2	20
V.24.110.15.01	VSTAS-2	500-800	600	165,5	183,5	-	-	6	2	20
V.24.120.15.01	VSTAS-3	700-1000	800	265,5	283,5	-	-	8	2	20
V.24.130.15.01	VSTAS-4	900-1200	1000	365,5	144	-	383,5	10	3	20
V.24.140.15.01	VSTAS-5	1100-1400	1200	465,5	144	-	483,5	10	3	20
V.24.150.15.01	VSTAS-6	1300-1600	1400	565,5	144	-	583,5	12	3	20
V.24.160.15.01	VSTAS-7	1500-1800	1600	665,5	144	-	683,5	13	3	20
V.24.170.15.01	VSTAS-8	1700-2000	1800	249,5	267,5	765,5	783,5	14	4	20
V.24.180.15.01	VSTAS-9	1900-2200	2000	282,5	300,5	865,5	883,5	16	4	20
V.24.190.15.01	VSTAS-10	2100-2400	2200	282,5	300,5	965,5	983,5	16	4	20

Side Hung Turn Only Systems

Поворотная система

Turn Only Espagnolette 7,5 mm Backset (Zamak Gearbox - Standard Locking Pin)

Поворотный Механизм 7,5 мм. (корпус замка)

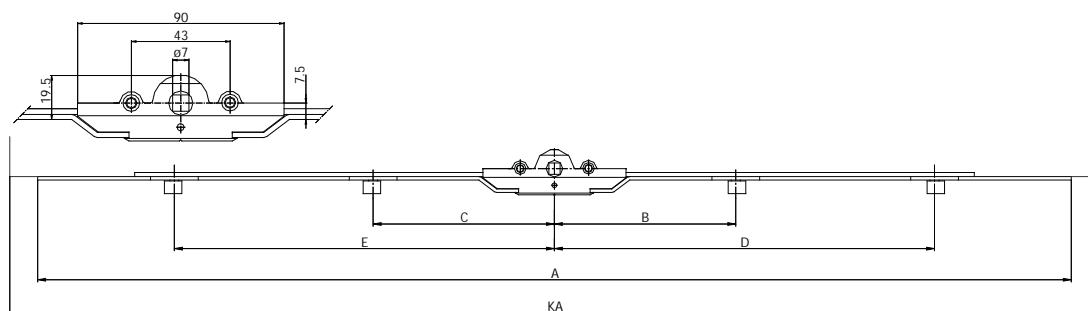

	KA Usage Length	A	B	C	D	E			
V.110.021.207.200	210-280	210	-	-	-	50,5	2	1	50
V.110.028.207.200	280-400	280	-	-	74	74	2	2	50
V.110.040.207.200	400-600	400	-	-	135	135	3	2	50
V.110.060.207.200	600-800	600	-	-	175	175	8	2	50
V.110.080.207.200	800-1000	800	-	-	275	275	8	2	50
V.110.100.207.200	1000-1200	1000	94	-	375	375	10	3	50
V.110.120.207.200	1200-1400	1200	94	-	475	475	10	3	50
V.110.140.207.200	1400-1600	1400	266	266	575	575	10	4	25
V.110.160.207.200	1600-1800	1600	300	300	675	675	12	4	25
V.110.180.207.200	1800-2000	1800	300	300	775	775	12	4	25
V.110.200.207.200	2000-2200	2000	300	300	875	875	12	4	25

Sliding Espagnolette 7,5 mm Backset (Zamak Gearbox - Security Locking Pin)

Раздвижной Механизм 7,5 мм. (корпус замка)

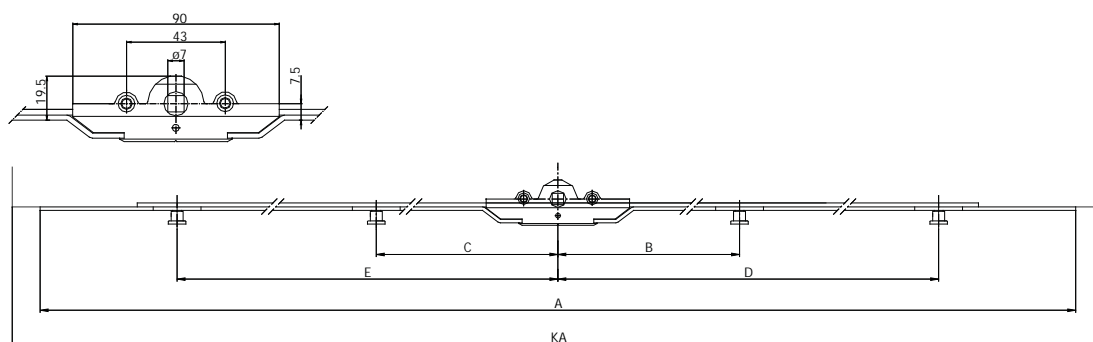

	KA Usage Length	A	B	C	D	E			
V.110.021.307.200	210-280	210	-	-	-	50,5	2	1	50
V.110.028.307.200	280-400	280	-	-	74	74	2	2	50
V.110.040.307.200	400-600	400	-	-	135	135	3	2	50
V.110.060.307.200	600-800	600	-	-	175	175	8	2	50
V.110.080.307.200	800-1000	800	-	-	275	275	8	2	50
V.110.100.307.200	1000-1200	1000	94	-	375	375	10	3	50
V.110.120.307.200	1200-1400	1200	94	-	475	475	10	3	50
V.110.140.307.200	1400-1600	1400	266	266	575	575	10	4	25
V.110.160.307.200	1600-1800	1600	300	300	675	675	12	4	25
V.110.180.307.200	1800-2000	1800	300	300	775	775	12	4	25
V.110.200.307.200	2000-2200	2000	300	300	875	875	12	4	25

Side Hung Turn Only Systems Поворотная система



Turn Only Espagnolette 22 mm Backset (Zamak Gearbox - Standard / Security Locking Pin) Поворотный Механизм 22 мм. (корпус замка)

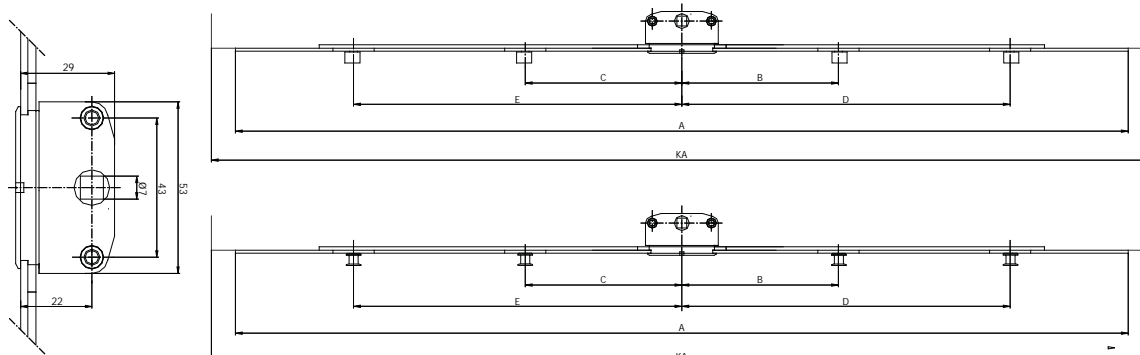

(Standard Pin)	(Security Pin)	KA Usage Length	A	B	C	D	E			
V.110.021.222.200	V.110.021.922.200	210-280	210	-	-	-	50,5	2	1	10
V.110.028.222.200	V.110.028.922.200	280-400	280	-	-	74	74	2	2	10
V.110.040.222.200	V.110.040.922.200	400-600	400	-	-	135	135	4	2	10
V.110.060.222.200	V.110.060.922.200	600-800	600	-	-	175	175	8	4	10
V.110.080.222.200	V.110.080.922.200	800-1000	800	-	-	275	275	8	4	10
V.110.100.222.200	V.110.100.922.200	1000-1200	1000	94	-	375	375	10	3	10
V.110.120.222.200	V.110.120.922.200	1200-1400	1200	94	-	475	475	10	3	10
V.110.140.222.200	V.110.140.922.200	1400-1600	1400	266	266	575	575	10	4	10
V.110.160.222.200	V.110.160.922.200	1600-1800	1600	300	300	675	675	12	4	10
V.110.180.222.200	V.110.180.922.200	1800-2000	1800	300	300	775	775	12	4	10
V.110.200.222.200	V.110.200.922.200	2000-2200	2000	300	300	875	875	12	4	10

Sliding Espagnolette 22 mm Backset (Zamak Gearbox - Security Locking Pin) Раздвижной Механизм 22 мм. (корпус замка)

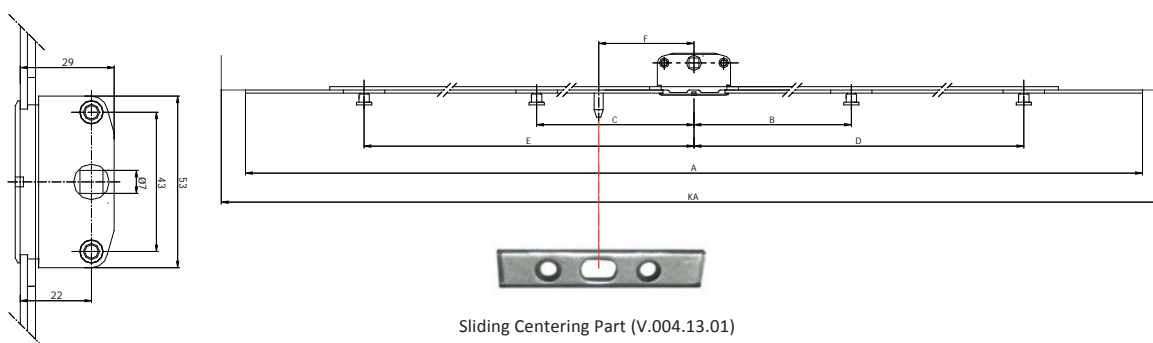

	KA Usage Length	A	B	C	D	E	F			
V.110.060.322.200	600-800	600	-	-	175	175	106,5	8	2	10
V.110.080.322.200	800-1000	800	-	-	275	275	166,5	8	2	10
V.110.100.322.200	1000-1200	1000	94	-	375	375	131,5	10	3	10
V.110.120.322.200	1200-1400	1200	94	-	475	475	166	10	3	10
V.110.140.322.200	1400-1600	1400	266	266	575	575	166	10	4	10
V.110.160.322.200	1600-1800	1600	300	300	675	675	200	12	4	10
V.110.180.322.200	1800-2000	1800	300	300	775	775	200	12	4	10
V.110.200.322.200	2000-2200	2000	300	300	875	875	200	12	4	10

Side Hung Turn Only Systems Поворотная система



Turn Only Espagnolette 25 mm Backset (Zamak Gearbox - Standard / Security Locking Pin) Поворотный Механизм 25 мм. (корпус замка)

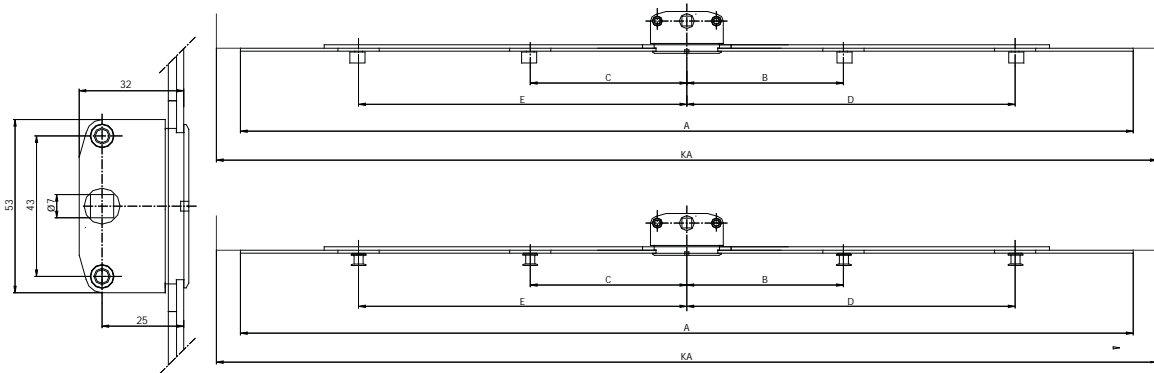

(Standard Pin)	(Security Pin)	KA Usage Length	A	B	C	D	E			
V.110.021.225.200	V.110.021.925.200	210-280	210	-	-	-	50,5	2	1	10
V.110.028.225.200	V.110.028.925.200	280-400	280	-	-	74	74	2	2	10
V.110.040.225.200	V.110.040.925.200	400-600	400	-	-	135	135	4	2	10
V.110.060.225.200	V.110.060.925.200	600-800	600	-	-	175	175	8	4	10
V.110.080.225.200	V.110.080.925.200	800-1000	800	-	-	275	275	8	4	10
V.110.100.225.200	V.110.100.925.200	1000-1200	1000	94	-	375	375	10	3	10
V.110.120.225.200	V.110.120.925.200	1200-1400	1200	94	-	475	475	10	3	10
V.110.140.225.200	V.110.140.925.200	1400-1600	1400	266	266	575	575	10	4	10
V.110.160.225.200	V.110.160.925.200	1600-1800	1600	300	300	675	675	12	4	10
V.110.180.225.200	V.110.180.925.200	1800-2000	1800	300	300	775	775	12	4	10
V.110.200.225.200	V.110.200.925.200	2000-2200	2000	300	300	875	875	12	4	10

Sliding Espagnolette 25 mm Backset (Zamak Gearbox - Security Locking Pin) Раздвижной Механизм 25 мм. (корпус замка)

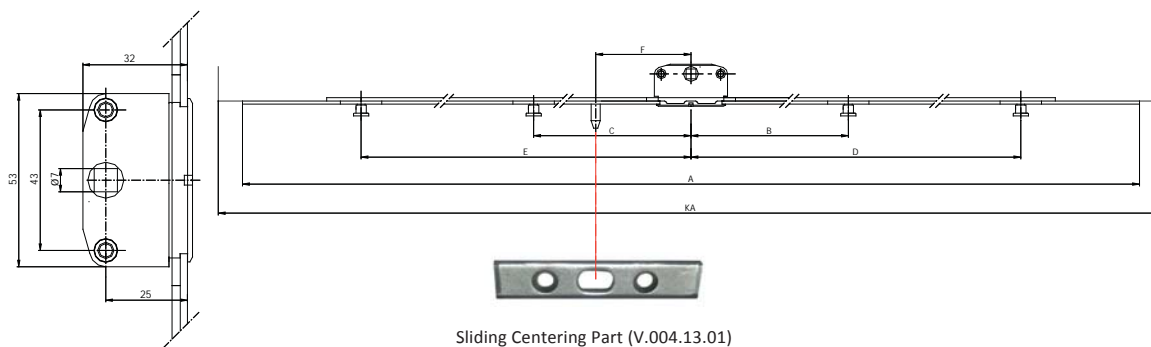

Sliding Centering Part (V.004.13.01)







	KA Usage Length	A	B	C	D	E	F			
V.110.060.325.200	600-800	600	-	-	175	175	106,5	8	2	10
V.110.080.325.200	800-1000	800	-	-	275	275	166,5	8	2	10
V.110.100.325.200	1000-1200	1000	94	-	375	375	131,5	10	3	10
V.110.120.325.200	1200-1400	1200	94	-	475	475	166	10	3	10
V.110.140.325.200	1400-1600	1400	266	266	575	575	166	10	4	10
V.110.160.325.200	1600-1800	1600	300	300	675	675	200	12	4	10
V.110.180.325.200	1800-2000	1800	300	300	775	775	200	12	4	10
V.110.200.325.200	2000-2200	2000	300	300	875	875	200	12	4	10

Side Hung Turn Only Systems Поворотная система

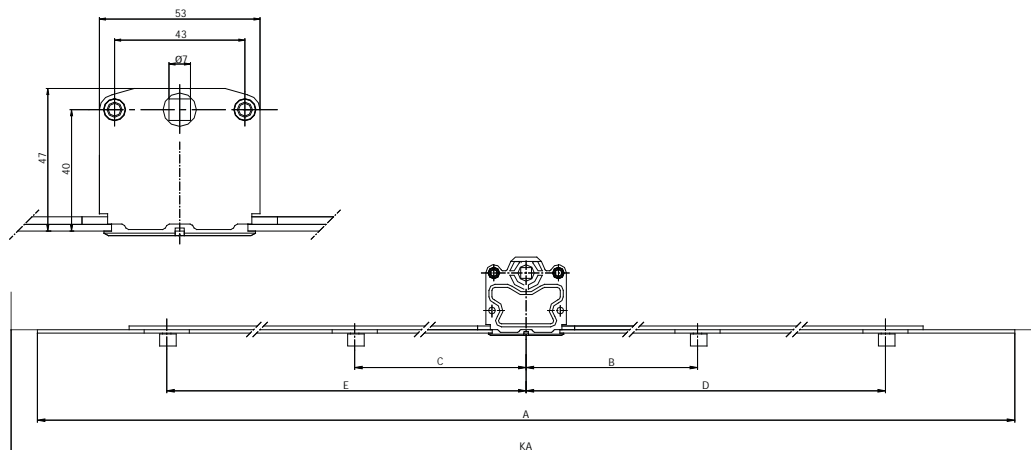

Turn Only Espagnolette 40 mm Backset (Zamak Gearbox - Standard Locking Pin)
Поворотный Механизм 40 мм. (корпус замка)



	KA Usage Length	A	B	C	D	E			
V.110.160.240.200	1600-1800	1600	300	300	675	675	10	3	10
V.110.180.240.200	1800-2000	1800	300	300	775	775	12	4	10
V.110.200.240.200	2000-2200	2000	300	300	875	875	12	4	10

Side Hung Turn Only Systems Поворотная система



Sliding Espagnolette 15 mm Backset (Zamak Gearbox - Standard Pin - Additional Lock)
Раздвижной Механизм с Замком 15 мм. (корпус замка)

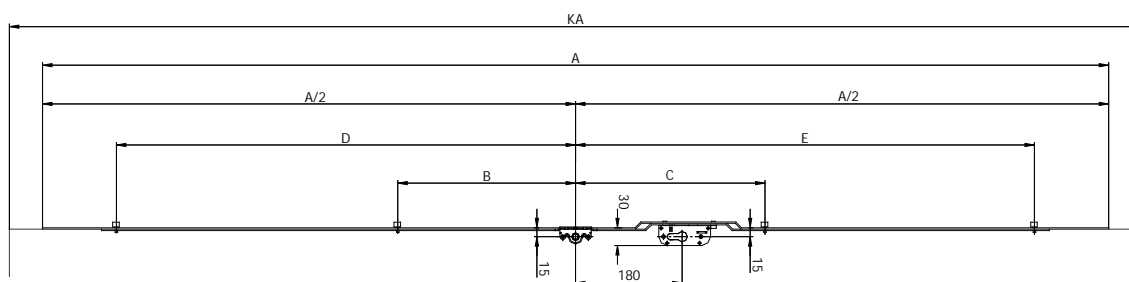
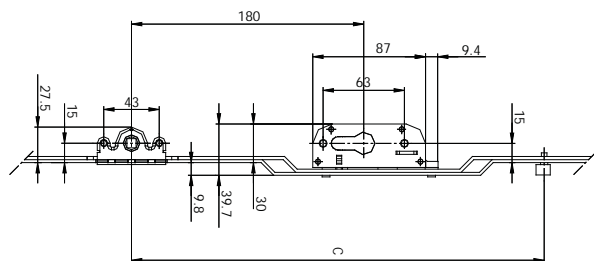





	KA Usage Length	A	A/2	B	C	D	E			
V.110.160.315.203	1600-1800	1600	800	-	-	675	675	10	3	10
V.110.180.315.203	1800-2000	1800	900	300	320	775	775	12	4	10
V.110.200.315.203	2000-2200	2000	1000	300	320	875	875	12	4	10

Side Hung Turn Only Systems Поворотная система

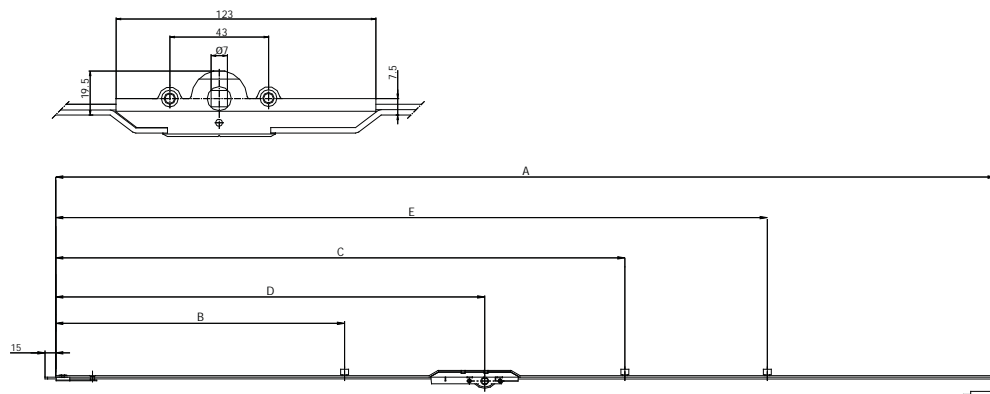

Fixed Handle Height Reversing Espagnolette 7,5 mm Backset (Zamak Gearbox - Standard Pin)
Поворотно-противоположные проивод, дорнмац 7,5 мм



	KA Usage Length	A	B	C	D	E			
V.110.055.615.200	-	556	-	-	155	-	3	-	10
V.110.075.620.200	-	756	-	-	200	-	3	-	10
V.110.085.625.200	-	856	-	396	250	-	5	1	10
V.110.110.640.200	-	1106	-	546	400	-	5	1	10
V.110.135.640.200	-	1356	-	546	400	-	6	1	10
V.110.135.650.200	-	1356	-	646	500	-	7	1	10
V.110.160.650.200	-	1606	-	796	500	-	8	1	10
V.110.185.650.200	-	1856	-	796	500	1396	9	2	10
V.110.160.660.200	-	1606	-	796	600	-	8	1	10
V.110.185.660.200	-	1856	-	796	600	1396	9	2	10
V.110.210.660.200	-	2106	-	796	600	1396	10	2	10
V.110.210.670.200	-	2106	-	896	700	1396	10	2	10
V.110.235.670.200	-	2356	-	896	700	1396	11	2	10
V.110.210.698.200	-	2106	596	1396	980	-	10	2	10
V.110.235.698.200	-	2356	596	1396	980	-	11	2	10